



PANDUL

THE PENDANT

DESIGN > HANS J. WEGNER



WHITE PENDANT : WHITE CABLE LIFT
BLACK PENDANT : BLACK CABLE LIFT
ALUMINIUM PENDANT : BLACK CABLE LIFT
GRAY PENDANT : BLACK CABLE LIFT

THE PENDANT L037
PENDANT WITH CABLE LIFT
WEIGHT 1.8 KG



MAX.100W REGULAR INCANDESCENT
BULB OR SIMILAR SIZE
FLUORESCENT BULB

HAND MADE IN EVERY DETAIL FROM
WET PAINTED ALUMINIUM SHADE TO THE
HANGER

WHITE WITH METAL HANGER
BLACK WITH METAL HANGER
ALUMINIUM WITH BLACK METAL HANGER
GRAY WITH METAL HANGER

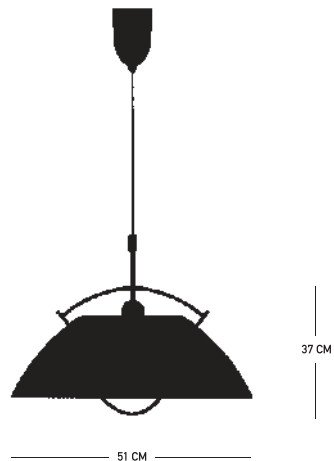

OPALA PENDANT

DESIGN > HANS J. WEGNER



OPALA L038 - PENDANT

SHADE MANUFACTURED IN IMPACT
RESISTENT OPAL HIGH GLOSS ACRYLIC.
TOP IN WET PAINTED ALUMINIUM.
400 CM OF TEXTILE CORD
MAX. 170 DEGREES C



MAX 75W REGULAR INCANDESCENT
BULB OR SIMILAR SIZE
FLUORESCENT BULB

WEIGHT : 2.1 KG
DIAMETER : 43.0 CM - HEIGHT : 20.5 CM

OPALA L039 - PENDANT

SHADE MANUFACTURED IN IMPACT
RESISTENT OPAL HIGH GLOSS ACRYLIC.
TOP IN WET PAINTED ALUMINIUM.
400 CM OF TEXTILE CORD
MAX. 170 DEGREES C



MAX 100W REGULAR INCANDESCENT
BULB OR SIMILAR SIZE
FLUORESCENT BULB.

WEIGHT : 2.3 KG
DIAMETER : 51.5 CM - HEIGHT : 28.5 CM

BLACK TOP AND CORD
WHITE TOP AND CORD

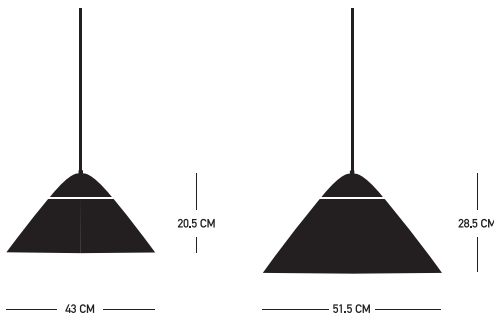

OPALA TABLE

DESIGN > HANS J. WEGNER



OPALA B001 BED SIDE LIGHT & TABLE LIGHT



REGULAR GOLF BALL BULB
MAX. 60W OR SIMILAR SIZE
FLUORESCENT BULB

BLACK CORD 3.30 M

STANDARD EQUIPPED WITH AN
ON CORD SWITCH

WEIGHT : 2.7 KG

STANDARD COLOUR : BLACK WITH CHROME

OPALA B002 TABLE LIGHT & DESK LIGHT

SHADE MANUFACTURED IN IMPACT RESISTENT
OPAL HIGH GLOSS ACRYLIC.
TOP IN WET PAINTED ALUMINIUM.
STAND IN HIGH GLOSS CHROME AND BASE
IN WET PAINTED SOLID STEEL.



REGULAR INCANDESCENT BULB
MIN. 60W - MAX. 75W OR SIMILAR SIZE
FLUORESCENT BULB.
(FLUORESCENT BULBS DO NOT YET WORK
WITH DIMMERS)

BLACK CORD 3.30 M

STANDARD EQUIPPED WITH AN ELECTRONIC.
ENERGY SAVING ON CORD DIMMER.

PLEASE ORDER WITH ORDINARY
ON CORD SWITCH FOR USE WITH
FLUORESCENT BULBS

WEIGHT : 3.0 KG

STANDARD COLOUR : BLACK WITH CHROME

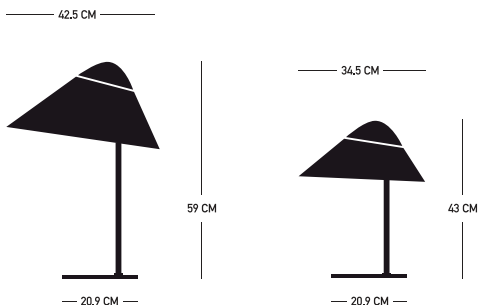

OPALA FLOOR

DESIGN > HANS J. WEGNER



OPALA G003 / G004
FLOOR LIGHT

SHADE MANUFACTURED IN IMPACT
RESISTENT OPAL HIGH GLOSS ACRYLIC.
TOP IN WET PAINTED ALUMINIUM.
STAND IN HIGH GLOSS CHROME AND BASE
IN WET PAINTED SOLID STEEL



REGULAR INCANDESCENT BULB.
MIN. 60W - MAX. 75W OR SIMILAR SIZE
FLUORESCENT BULB.
(FLUORESCENT BULBS DO NOT YET WORK
WITH DIMMERS)

BLACK CORD : 2.40 M
STANDARD EQUIPPED WITH AN
ELECTRONIC, ENERGY SAVING
ON CORD DIMMER

PLEASE ORDER WITH ORDINARY ON CORD
SWITCH FOR USE WITH FLUORESCENT BULBS

WEIGHT : 6.3 / 6.4 KG

STANDARD COLOUR : BLACK WITH CHROME

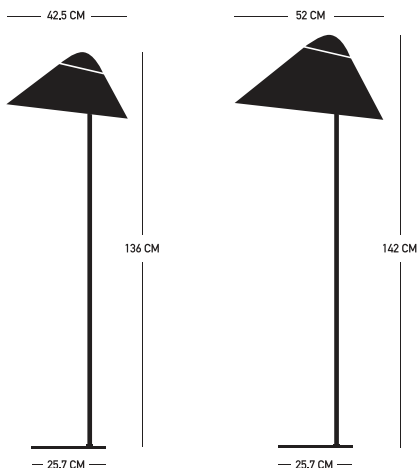

SWING VIP

DESIGN > JØRGEN GAMMELGAARD



SWING VIP B005
TABLE LAMP

WIRE : 300 CM



MAX. 100W REGULAR INCANDESCENT
BULB OR SIMILAR SIZE
FLUORESCENT BULB

SHADE MANUFACTURED IN WET PAINTED
ALUMINIUM, BASE IN WET PAINTED SOLID
STEEL AND STAND IN BRUSHED STAINLESS
STEEL

WHITE
BLACK

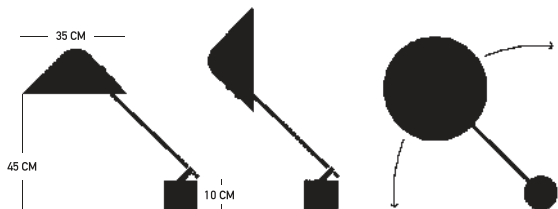

TABLE VIP

DESIGN > JØRGEN GAMMELGAARD



TABLE VIP B015
TABLE LAMP

CORD: 300 CM



MAX. 100W REGULAR
INCANDESCENT BULB OR SIMILAR
PHYSICAL SIZE FLUORESCENT,
HALOGEN OR LED BULB SOCKET:
E27 OR E26

SHADE MANUFACTURED IN WET PAINTED
ALUMINIUM, BASE IN WET PAINTED SOLID
STELL AND STAND IN BRUSHED STAINLESS
STELL

WHITE
BLACK

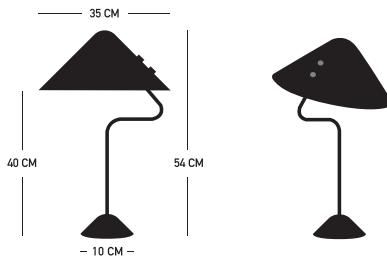

FLOOR VIP

DESIGN > JØRGEN GAMMELGAARD



FLOOR VIP G001

ADJUSTABLE SHADE & HEIGHT

SHADE MANUFACTURED IN WET PAINTED ALUMINIUM. BASE IN WET PAINTED SOLID STEEL. STAND IN WET PAINTED ALUMINIUM AND BRUSHED STAINLESS STEEL

CORD - 270 CM



MAX. 100W REGULAR INCANDESCENT BULB OR SIMILAR SIZE FLUORESCENT BULB

WHITE
BLACK

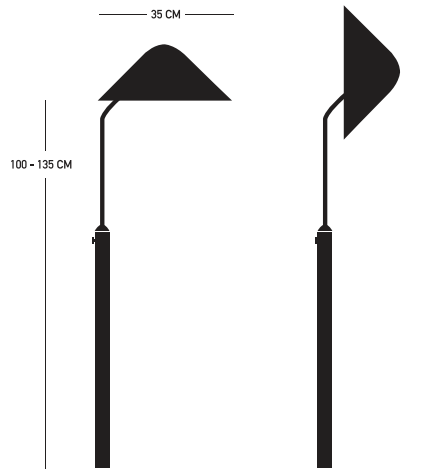

WALL VIP

DESIGN > JØRGEN GAMMELGAARD



WALL VIP V029
WALL LAMP

WIRE : 300 CM



MAX. 100W REGULAR INCANDESCENT
BULB OR SIMILAR
SIZE FLUORESCENT BULB

BRUSHED STAINLESS STEEL WITH SHADE
MANUFACTURED IN WET PAINTED
ALUMINIUM

WHITE
BLACK
OPAL POLYCARBONATE

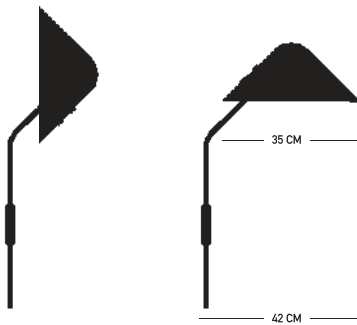

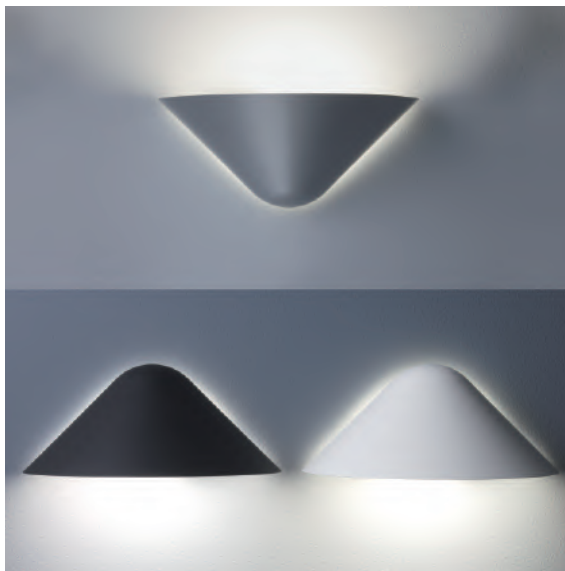

1/2 VIP V021
WALL LAMP INDOOR / OUTDOOR

 E14 - GOLF BALL BULB
MAX. 40W OR SIMILAR SIZE
FLUORESCENT BULB
RAINPROOF IP 23
CLASS 1

VIP V021 L
WALL LAMP INDOOR / OUTDOOR

 10W
RAINPROOF IP 23
CLASS 1

WALL SCONCE : CAST IN SALT WATER
RESISTANT ALUMINIUM & POLYCARBONATE

HOLDER : STAINLESS STEEL

WHITE
BLACK



MINI VIP

DESIGN > JØRGEN GAMMELGAARD



MINI VIP V022
CORD : 400 CM



REGULAR GOLF BALL BULB
MAX. 40W OR SIMILAR SIZE
FLUORESCENT BULB

SHADE MANUFACTURED IN ALUMINIUM

WHITE
BLACK

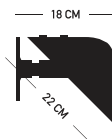
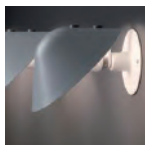

MINI VIP V025 & MINI VIP OPAL V025P
CORD : 400 CM



MAX. 60W REGULAR INCANDESCENT
BULB OR SIMILAR SIZE
FLUORESCENT BULB

SHADE MANUFACTURED IN ALUMINIUM
OR IN OPAL POLYCARBONATE

WHITE
BLACK

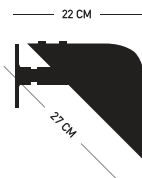

L032



-19.5 CM-

L033



-25.5 CM-

L034



-36 CM-

L036

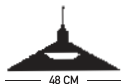

-48 CM-

L040



-19.5 CM-

V040



-19.5 CM-
-25 CM-

LAMP 2 L032
WIRE : 400 CM

 REGULAR GOLF BALL BULB
MAX. 40W OR SIMILAR SIZE
FLUORESCENT BULB

LAMP 3 L033 / LAMP 4 L034 / LAMP 6 L036
WIRE : 400 CM

 MAX. 75W REGULAR INCANDESCENT
BULB OR SIMILAR SIZE
FLUORESCENT BULB

SHADE, TOP AND ANTI GLARE RING
MANUFACTURED IN WET PAINTED
ALUMINIUM

WHITE
BLACK
ALUMINIUM

 TIP-TOP PENDANT L040
30 CM WIRE : 400 CM
MAX. 60W

SHADES AND TOP MANUFACTURED
IN WET PAINTED ALUMINIUM

WHITE
BLACK / ALUMINIUM
ALUMINIUM

 TIP-TOP WALL LAMP V040
30 CM WIRE : 400 CM
MAX. 60W

SHADES AND TOP MANUFACTURED
IN WET PAINTED ALUMINIUM

WHITE
BLACK/ALUMINIUM



RING / VALBY

DESIGN > ERIK MAGNUSSEN

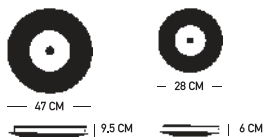

RING VL031
WALL- / CEILING LAMP

INDOOR IP 20
OUTDOOR IP 44



2 X 7W
2 X 9W
CLASS 1

INDOOR : WHITE / STAINLESS STEEL
OUTDOOR :
WHITE / STAINLESS STEEL / COPPER

RING VL047
WALL- / CEILING LAMP

INDOOR IP 20



2 X 36W
DULUX F
CLASS 1

INDOOR : WHITE / BRUSHED ALUMINIUM

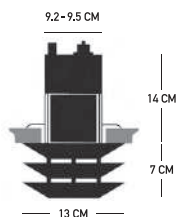

VALBY L071
CEILING LAMP

L071A : ALUMINIUM LACQUERED
L071H : WHITE
MATERIAL : IRON

SOCKET : G24 D-1, 2-PIN
LIGHT SOURCE :

10 W COMPACT LIGHT TUBE

WEIGHT : 0.95 KG



MAGNUSSEN UPLIGHT

DESIGN > ERIK MAGNUSSEN



PENDANT UPLIGHT L074



MAX. 4 X 100W REGULAR
INCANDESCENT BULBS OR SIMILAR
SIZE FLUORESCENT BULBS

PENDANT UPLIGHT L074 L



4 X 26W TC-D
CLASS 1
WEIGHT 6.5 KG

SHADE : ALUMINIUM & POLYCARBONATE

WHITE
ALUMINIUM

— 16 CM —



40 - 70 CM

10 CM

74 CM

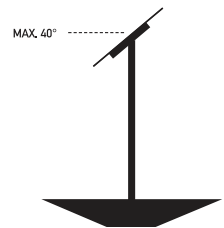



BUBI L020 - PENDANT

SHADE MANUFACTURED IN OPAL
IMPACT-RESISTANT HIGH-GLOSS ACRYLIC.

HANDMADE TOP IN CHROME STEEL.

300 CM OF TEXTILE CORD.

 MAX 12W
 FLUORESCENT BULB.

WEIGHT : 1.3 KG

DIAMETER : 22 CM - HEIGHT : 16 CM

STANDARD COLOUR :
CHROME TOP WITH WHITE OR BLACK CORD.

CORD ALSO AVAILABLE IN VARIOUS COLOURS
EACH SEASON.

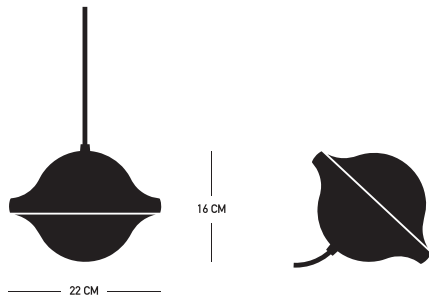

MADE IN DENMARK

台灣總代理 式澳國際 森/CASA www.moricasa.com

台北 02-87738951 台北市敦化南路一段245號 (誠品敦南店B1) · 台中 04-22262157 台中市西區五權路4號 · 台南 06-2227672 台南市金華路二段324號